



STAND

for Raasm products

**ADVANCED FLUID
MANAGEMENT SOLUTIONS**

Exalt the
quality

P/N 39484

- ✓ Bring out the articles
bring out the quality
- ✓ Let your customers
touch the best Made in
Italy manufactures
- ✓ Disclose RAASM's
elegance and design
- ✓ Customize the stand
how and when you want
- ✓ Place and fix the stand
easily and quickly





BENCH MOUNTING

The product's stand P/N 39484 is designed to host a lot of RAASM articles.

Universal holes on the bench and on the vertical panel allow an easy and safe mounting of the products, ensuring a great visibility.

On bench

you can mount:

- one or two grounding hose reels (version 735000)
- one or two hose reels of the S. 290, 330, 390 and 430
- one diaphragm pump S. 1120-AB
- one diaphragm pump S. 1000-AB
- one or two diaphragm pumps S. 120-PPAB
- up to four piston pumps S. 500, 600 and 650 (with appropriate bung adaptor)

On vertical panel

you can mount:

- up to three hose reels S. 250, 260, 280, 290, 300, 330, 390 and 430
- one diaphragm pump S. 120-PPAB or 1000-AB (with appropriate bracket)
- one diaphragm pump S. 120-AB, 120-PPAB or 120-PPB (with appropriate bracket)
- one gun with digital liter counter (with appropriate hook)
- one grease gun (with appropriate hook)

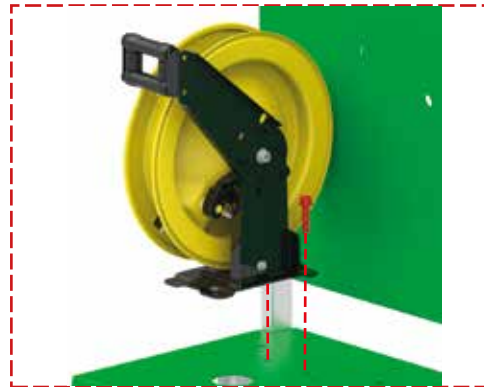

Holes for grounding hose reels P/N 735000 and versions with cable

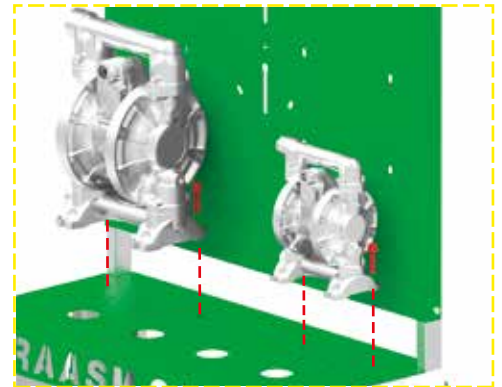

Holes for diaphragm pumps 1 1/2" S. 1120-AB

Holes for diaphragm pumps 1" S. 1000-AB

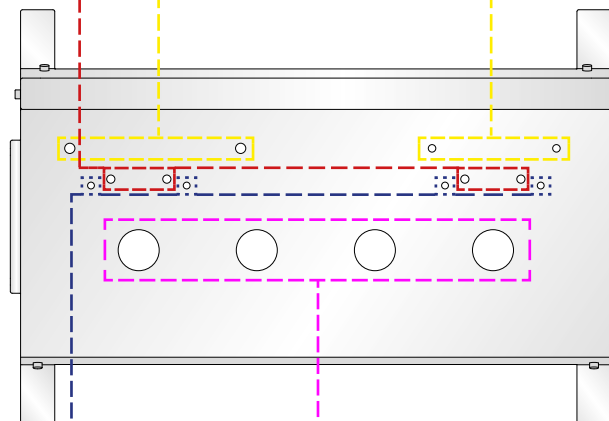

Holes for hose reels S. 290-330-390-430 diaphragm pumps 1/2" S. 120-PPAB



Holes for piston pumps S. 500 - 600 - 650 with bung adaptor P/N 38042 - 38044 - 38046 - 33434

VERTICAL PANEL MOUNTING



Grease gun supporting hook (included)



Holes for hose reels
250 - 260 - 280 - 290
300 - 330 - 390 - 430

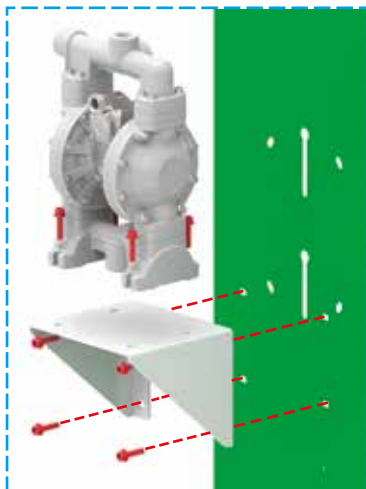

Holes for bracket P/N 33590 for diaphragm pumps 1/2" S. 120-AB, S. 120-PPAB e S. 120-PPB

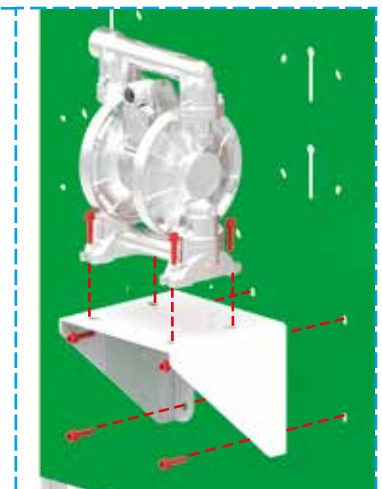

Holes for bracket P/N 33591 for diaphragm pumps 1/2" e 1" S. 120-PPB e S. 1000-AB

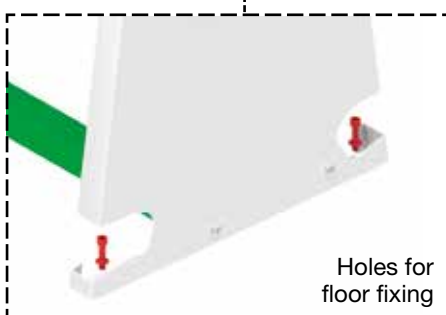
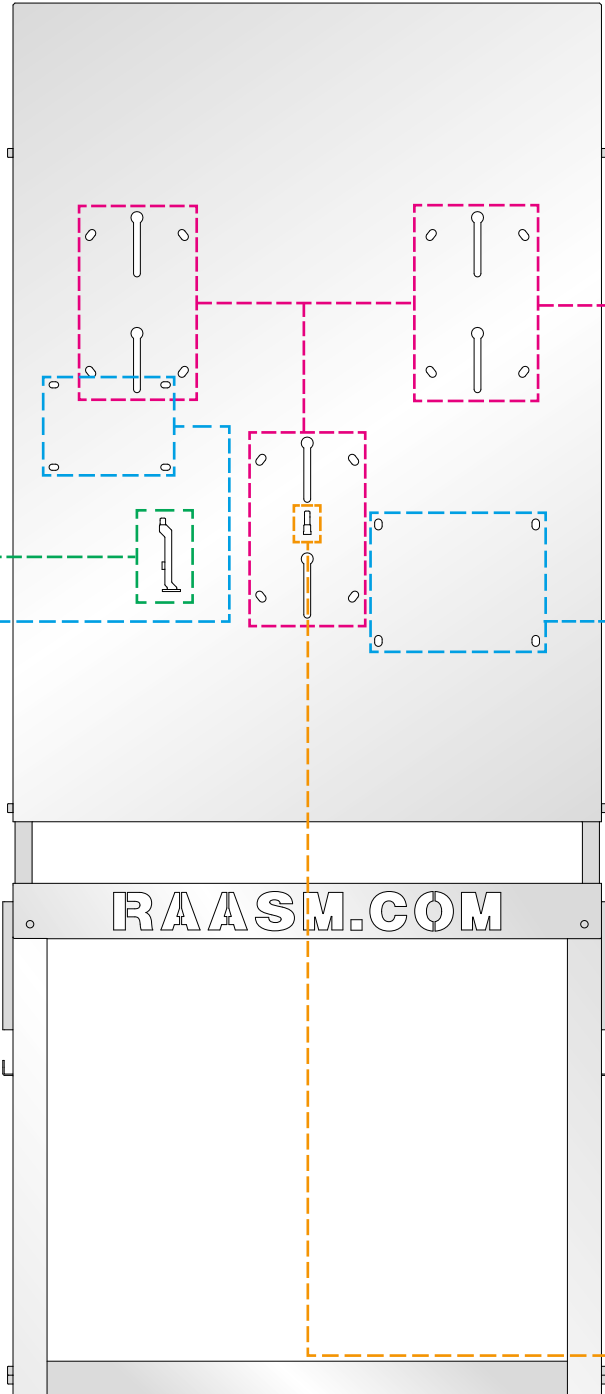

Holes for floor fixing



A4 leaflets pockets



Gun with digital liter counter supporting hook (included)

Supplied with

RAASM logo in aluminum serigraphy
Grease gun supporting hook
Gun with digital liter counter
supporting hook
Manual with mounting instructions

Optional

KR3948 Bolts and screws kit for the
floor fixing and articles mounting

Overall dimensions

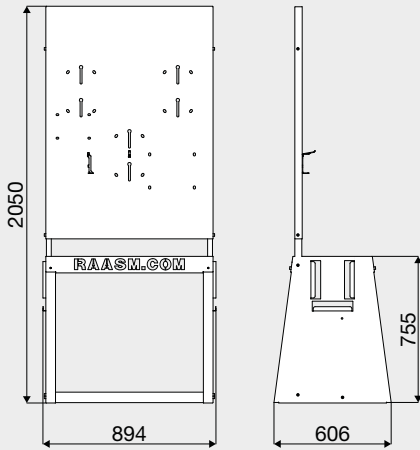

📦 N°1 packing m³ 0,42 📦 kg 70,6



RAASM S.p.A.

36022 S. ZENO DI CASSOLA (VI)
Via Marangoni, 33 - ITALY

Export department

Tel. +39 0424 571130
Fax 0424 571135

Technical department

Tel. +39 0424 571150
Fax 0424 571155

info@raasm.com
www.raasm.com

Stand



Stand with diaphragm pumps



Stand with hose reels



Mixed stand

