



## P/N 236540.300

Manual trolley-mounted hose reel s. 540, for hot water, 200 bar, without hose. Inlet G 3/8" (f), outlet G 1/2" (f). Hose guide, safety system and rotation lock as standard

### AREAS OF USE

Agriculture, Building and road construction, Manufacturing industry, Mining industry, Lube trucks and transports, Railway transport

### FEATURES

Pressure	200 bar
Compatible fluids	water max 130 °C
Swivel joint	AISI 304 stainless steel
Seals	Viton®
Characteristic	trolley-mounted
Material	painted steel with zinc plated steel trolley
Couplings	-
Hose	-
Ø and hose length	-
Inlet	G 3/8" (f)
Outlet	G 1/2" (f)
Reel flow path	AISI 304 stainless steel - zinc plated steel



### OVERALL DIMENSIONS (mm)

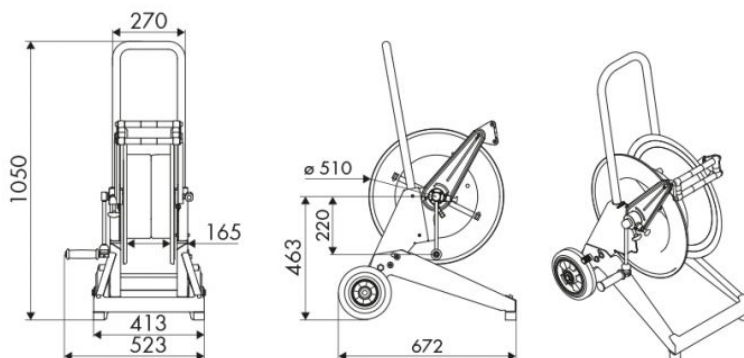

### HOSE REELS CAPACITY

Ø 1/4"	Ø 5/16"	Ø 3/8"	Ø 1/2"
150 m	110 m	65 m	45 m